

# DATI TECNICI

## TECHNICAL DATA

# MODULAR EASY

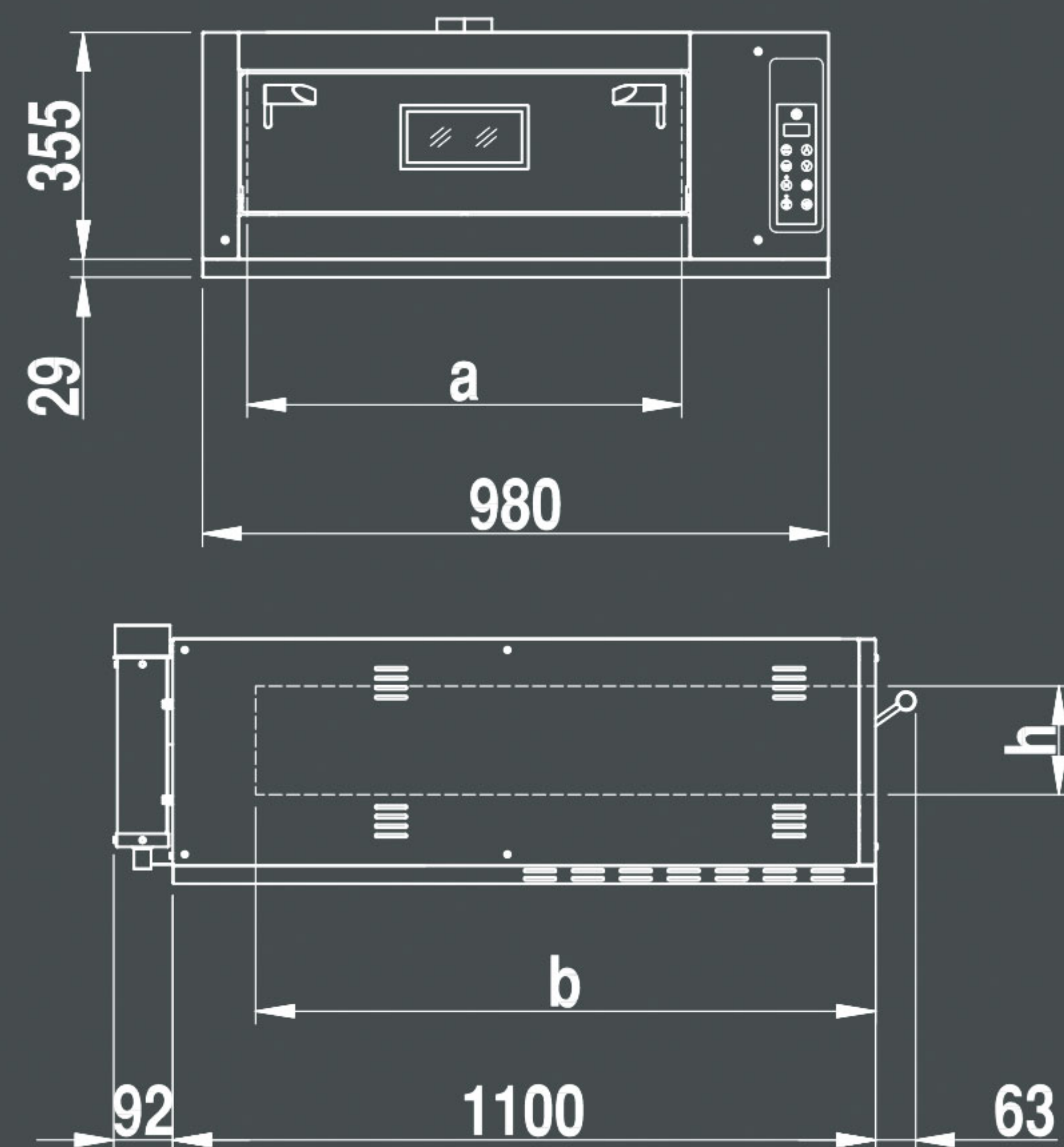

MODELLO MODEL	n. di teglie n. of trays	Dimensioni teglie trays dimensions	n. di pizze n. of pizzas D=30	dimensioni interne internal dimensions			Superficie utile useful surface (m <sup>2</sup> )	Potenza istallata installed power (kW)	MASSA WEIGHT (Kg)
				a	b	h			
EMTE2/6646	2	660x460	6	670	920	170	0,61	6,4	110

MODELLO MODEL	N. TEGLIE N. TRAYS	DIMENSIONI TEGLIE TRAYS DIMENSION mm	DIMENSIONI ESTERNE (mm) EXTERNAL DIMENSIONS (mm)			POTENZA ISTALLATA MAXIMUM POWER (kW)	MASSA WEIGHT (Kg)
			L	P	H		
BASE H=1000	9	600x400	920	1100	1000	-	35
BASE H=700	6	660x400			700	-	30
BASE H=500	-	-			500	-	20
EMTE CELLA 6646	12	660x400	980	1100	712	2	65
EMTE CAPP A 6646	-	660x400	980	1020	300	0,3	32

NOTA: \*per le vaporeiere assorbimento 0,75 kw cad. / NOTE: For the steam generator 0,75 kw each.

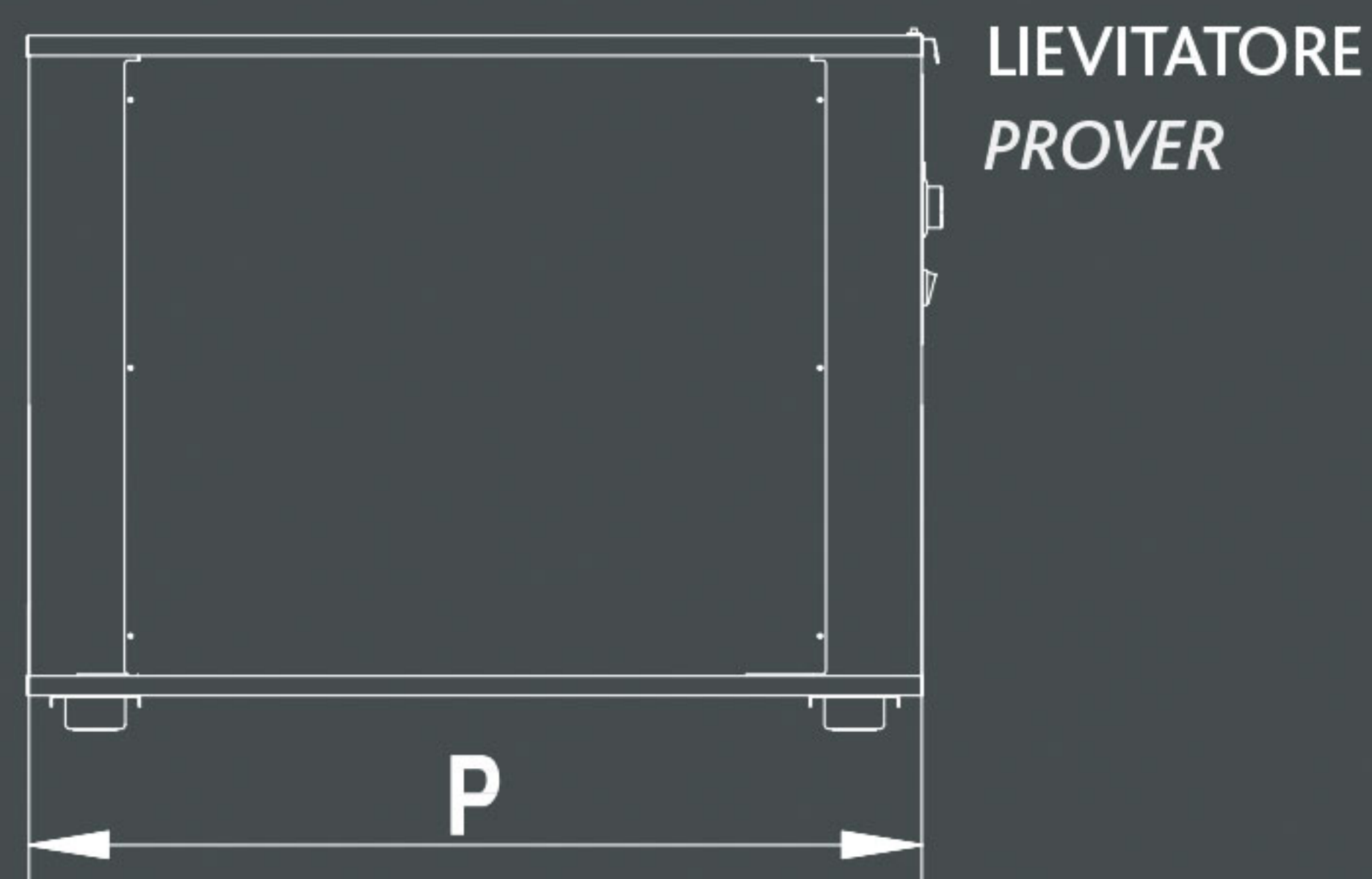
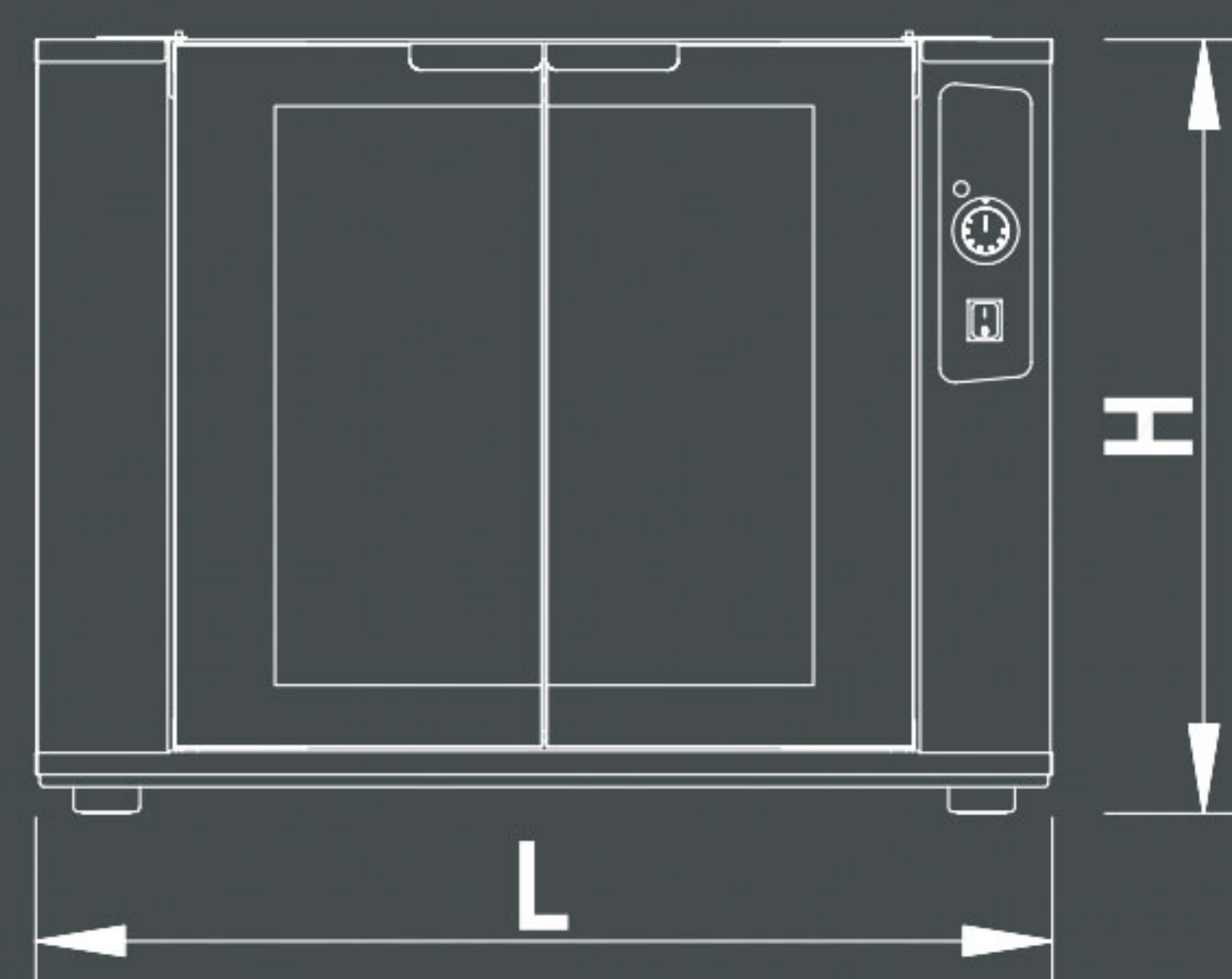

LIEVITATORE  
PROVER

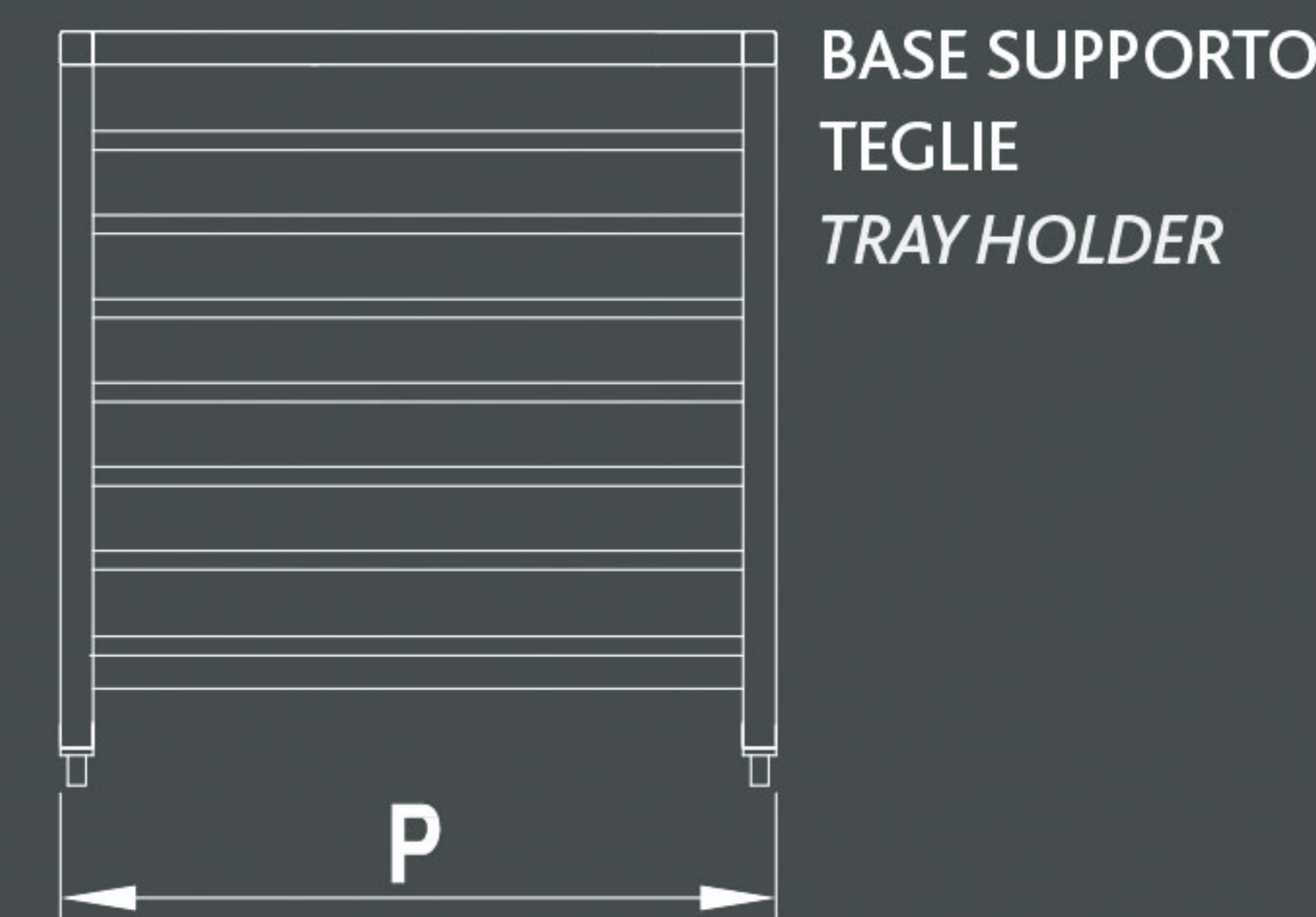
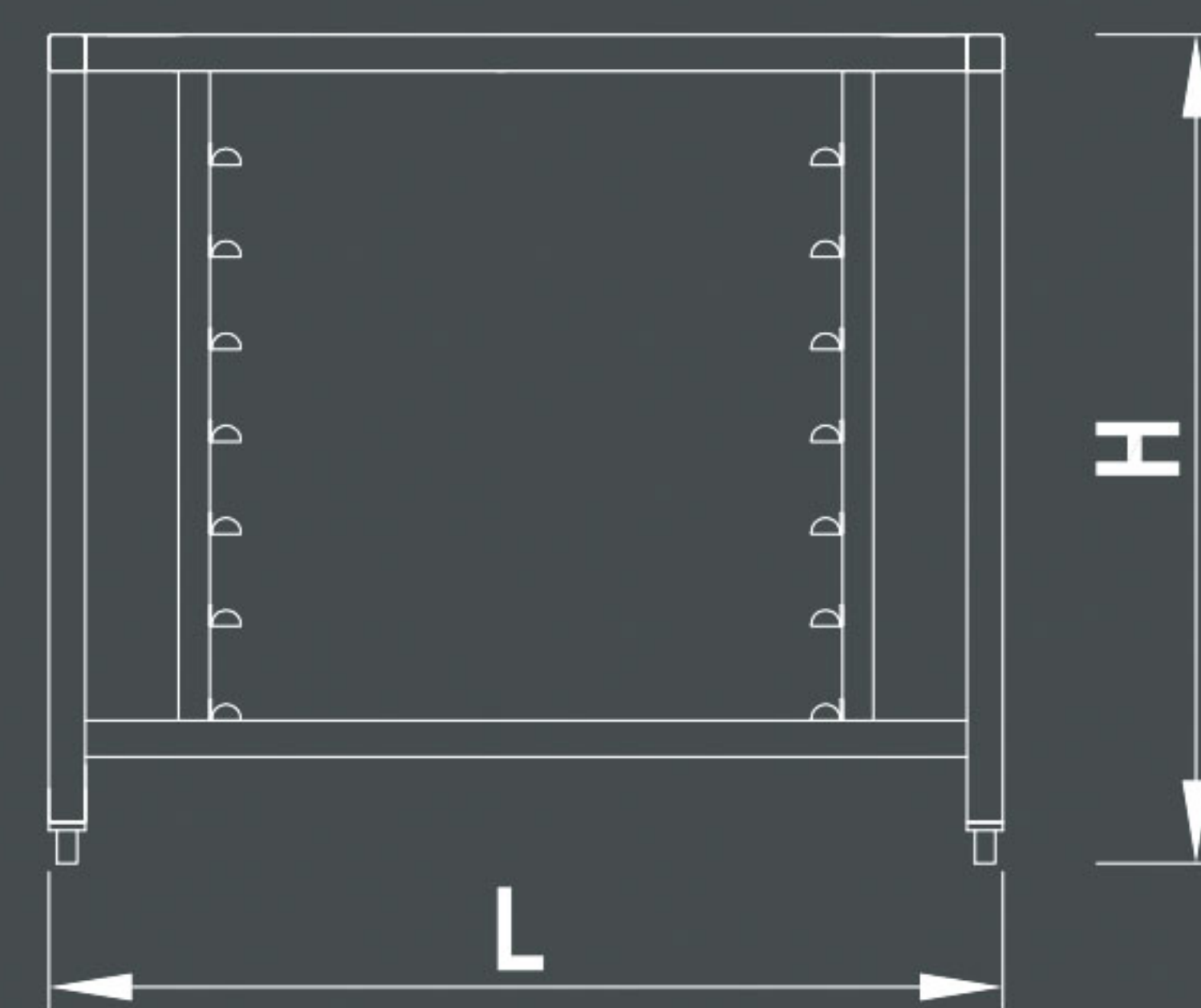

BASE SUPPORTO  
TEGLIE  
TRAY HOLDER

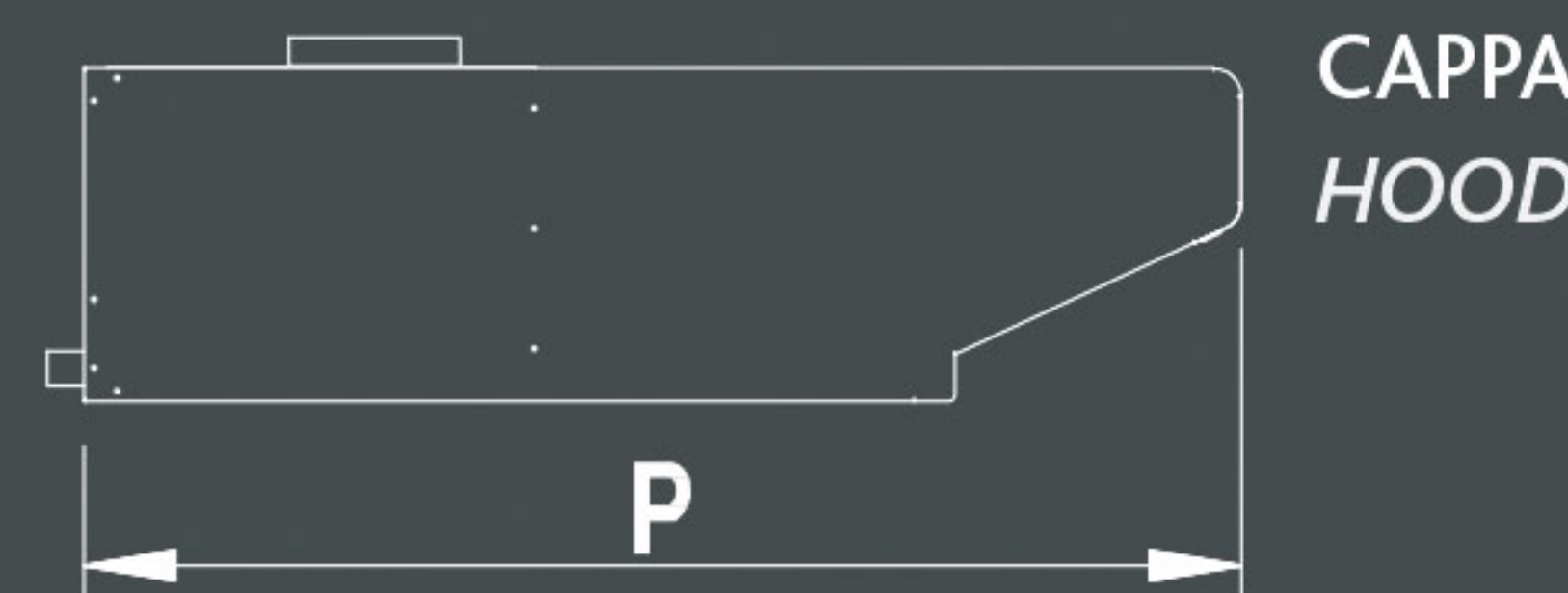
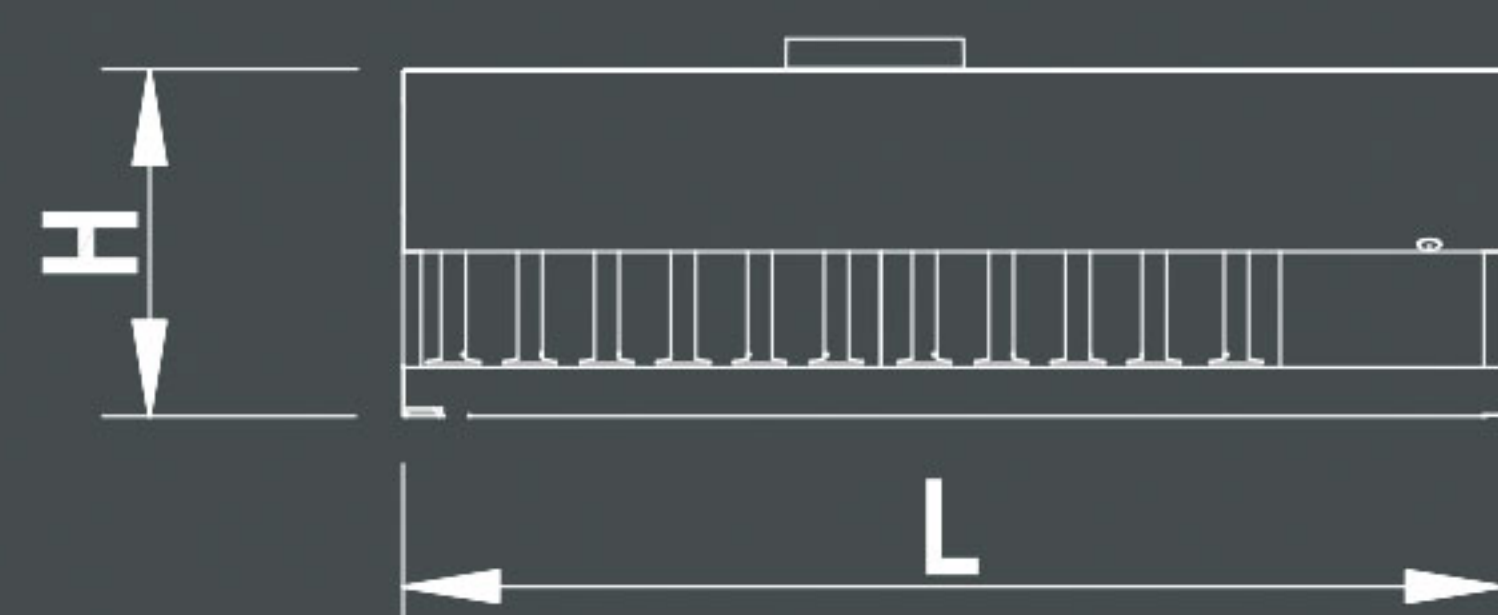

CAPPA  
HOOD